

Connect

Smart Sound multi room Instruction manual



 **Bluetooth®**   **Chromecast built-in**

The Bluetooth® word mark and logo are registered trademarks owned by Bluetooth SIG, Inc. and any use of such marks by Connect AS is under license. Other trademarks and trade names are those of their respective owners.

Google Home, Chromecast Built-in, and other related marks and logos are trademarks of Google LLC.

Quick Guide

1. Open box and check that all items are included.



Instruction manual



Remote Control

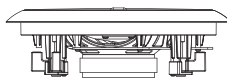

Speaker x 2

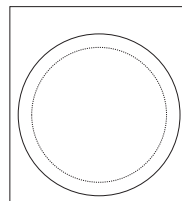

Template x 1



Flat washer x 4
M3 x 9 x T0.5mm



Screw x 4
PA4 x 12mm

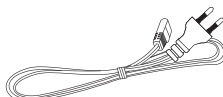

Power cable x 1



Speaker cable x 2

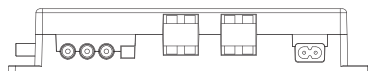

Main unit x 1

2. Install unit as described in manual.

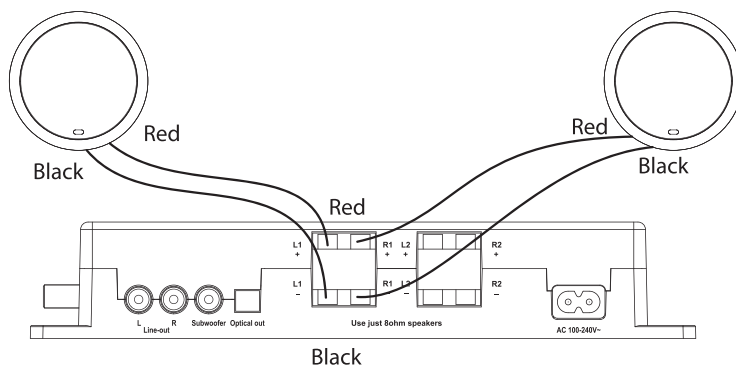

3. Download the Google Home App and set up the product.

4. Download and install the Connectz App to experience the full potential of the Smart Sound system.

Contents

Safety Warnings	4
Unpacking	6
Product Overview	7
Main Unit.....	7
Speakers	8
Remote Control	8
Preparation	9
Battery Replacement for the Remote Control	9
Remote Control Operation Range.....	9
Wall Mounting.....	10
Speakers System Placement.....	10
Connections	12
Connections for Audio Source Inputs	12
Connections for Audio Source Outputs	14
Connections to the Mains Supply.....	14
Full Units Setup	15
General Operations	17
Connecte APP	18
Maintenance	20
Hints and Tips	20
Product Specification	21

Safety Warnings

- Read all the instructions carefully before using the unit and keep them for future reference.
- Retain the manual. If you pass the unit onto a third party make sure to include this manual.
- Check that the voltage marked on the rating label matches your mains voltage.

Damage

- Please inspect the unit for damage after unpacking.
- Do not continue to operate the unit if you are in any doubt about it working normally, or if it is damaged in any way - switch off, withdraw the mains plug and consult your dealer.

Temperature

- Avoid extreme degrees of temperature, either hot or cold. Place the unit well away from heat sources such as radiators or gas / electric fires.
- Avoid exposure to direct sunlight and other sources of heat.
- Attention should be drawn to the use of apparatus in moderate climates.

Naked Flames

- Never place any type of candle or naked flame on the top of or near the unit.

Moisture

- To reduce the risk of fire, electric shock or product damage, do not expose this unit to rain, moisture, dripping or splashing. No objects filled with liquids, such as vases, should be placed on the unit. Do not operate the unit with wet hands, near water or other liquid.
- If you spill any liquid into the unit, it can cause serious damage. Switch it off at the mains immediately. Withdraw the mains plug and consult your dealer.

Ventilation

- To prevent the risk of electric shock or fire hazard due to overheating, ensure that curtains and other materials do not obstruct the ventilation vents.
- A minimum distance of 5 cm around the unit should be maintained to allow for sufficient ventilation.

Safety

- Always disconnect the unit from the mains supply before connecting / disconnecting other devices or moving the unit.
- Unplug the unit from the mains socket during a lightning storm.
- In the interests of safety and to avoid unnecessary energy consumption, never leave the unit switched on while unattended for long periods of time, e.g. overnight, while on holiday or while out of the house. Switch it off and disconnect the mains plug from the the mains socket.

Mains Cable

- Make sure the unit or unit stand is not resting on top of the mains cable, as the weight of the unit may damage the mains cable and create a safety hazard.
- If the mains cable is damaged it must be replaced by the manufacturer, its service agent, or similarly qualified persons in order to avoid a hazard.

Where the MAINS plug or an appliance coupler is used as the disconnect device, the disconnect device shall remain readily operable; the ventilation should not be impeded by covering the ventilation openings with items, such as newspapers, table-cloths, curtains, etc.



This equipment is a Class II or double insulated electrical appliance. It has been designed in such a way that it does not require a safety connection to electrical earth.

Interference

- Do not place the unit on or near appliances which may cause electromagnetic interference. If you do, it may adversely affect the operating performance of the unit, and cause a distorted picture or sound.

Batteries

- Batteries used in the remote control for this unit are easily swallowed by young children and this is dangerous.
- Keep loose batteries away from young children and make sure that the battery holder tray is secure in the remote control. Seek medical advice if you believe a cell has been swallowed.
- Please dispose of batteries correctly by following the guidance in this manual.
- Do not expose the battery to direct sunlight or sources of excessive heat.
- Attention should be drawn to the environmental aspects of battery disposal.

Supervision

- Children should be supervised to ensure that they do not play with the unit and the remote control.
- Never let anyone especially children push anything into the holes, slots or any other openings in the case - this could result in a fatal electric shock.



The lightning flash with arrowhead symbol, within an equilateral triangle, is intended to alert the user to the presence of uninsulated dangerous voltage within the units enclosure that may be of sufficient magnitude to constitute a risk of electric shock.



The exclamation point within an equilateral triangle is intended to alert the user to the presence of important operating and maintenance (servicing) instructions in the manual accompanying the unit.

Service

- To reduce the risk of electric shock, do not remove screws. The unit does not contain any user-serviceable parts. Please leave all maintenance work to qualified personnel.
- Do not open any fixed covers as this may expose dangerous voltages.

Maintenance

- Ensure to unplug the unit from the mains socket before cleaning.
- Do not use any type of abrasive pad or abrasive cleaning solutions as these may damage the units surface.
- Do not use liquids to clean the unit.



To prevent the spread of fire, keep candles or other open flames away from this product at all times.



The WEEE logo (shown at the left) appears on the product to indicate that this product must not be disposed off or dumped with your other household wastes. You are liable to dispose of all your electronic or electrical waste equipment by relocating over to the specified collection point for recycling. of such hazardous waste.

Notes for battery disposal

The batteries used with this product contain chemicals that are harmful to the environment. To preserve our environment, dispose of used batteries according to your local laws or regulations. Do not dispose of batteries with normal household waste.

For more information, please contact the local authority or your retailer where you purchased the product.



This device complies with the essential requirements and other relevant provisions of the RE Directive 2014/53/EU. the Ecodesign Directive 2009/125/EC and the RoHS Directive 2011/65/EU.

Thank you

for purchasing your new product.

We recommend that you spend some time reading this instruction manual in order that you fully understand all the operational features it offers. You will also find some hints and tips to help you resolve any issues.

Read all the safety instructions carefully before use and keep this instruction manual for future reference.

Unpacking

Remove all items from the packaging. Retain the packaging. If you dispose of it please do so according to local regulations.

The following items are included:



Instruction manual



Remote Control



Flat washer x 4
M3 x 9 x T0.5mm

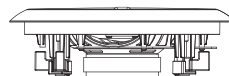

Speaker x 2

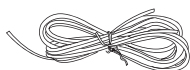

Speaker cable x 2

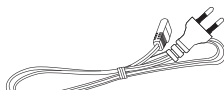

Power cable x 1

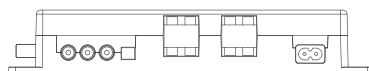

Main unit x 1



Screw x 4
PA4 x 12mm

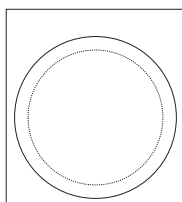

Template x 1

Product Overview

Main Unit

Front View

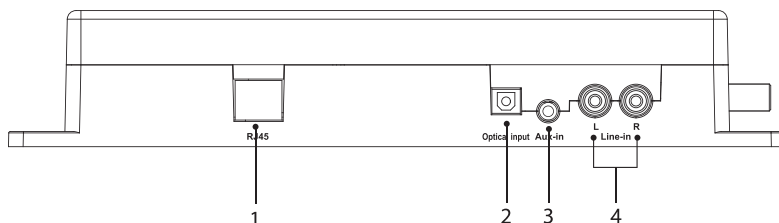

1. RJ45
Ethernet port for connecting to router
2. Optical Input Socket
3. AUX-in Socket
4. Line-in(L/R) Socket

Side View

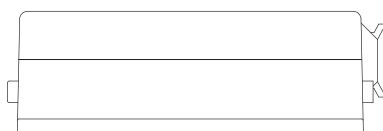

Rear View

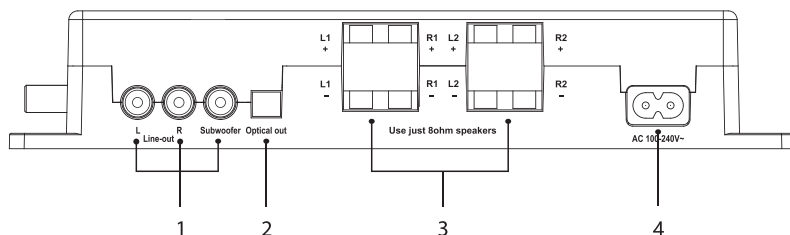

1. RCA Output Socket
2. Optical Output Socket
3. Speaker Connection Socket
Two sets of speakers can be connected to main unit. Each set includes two speakers, one is left channel, the other is right channel. Two sets of speakers play the same audio source.
4. Power Socket
AC 100V-240V

Speakers

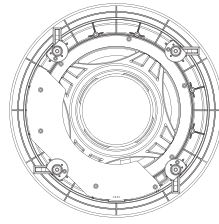
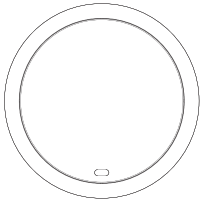

Remote Control

1. Button
If main unit is power on, press it to enter standby mode.
If main unit is in standby mode, press it to wake up.
2. Button
Short press this button to enter MUTE mode, press again to enter unmute mode.
3. Button
Short press for volume down, hold on this button to continue volume down. You can cancel mute mode.
4. Button
Short press for volume up, hold on this button to continue volume up. You can cancel mute mode.
5. Button
In radio mode, short press goes to last/next channel in favorite list.
6. Button
Press to play/pause playback in BT/CAST mode.
7. Button
In BT/CAST/RADIO mode, short press goes to last/next song.
8. Button
Change to **AUX/LINE IN** mode.
9. Button
Change to OPTICAL mode.
10. Button
Change to RADIO mode.
11. Button
Change to BT mode.

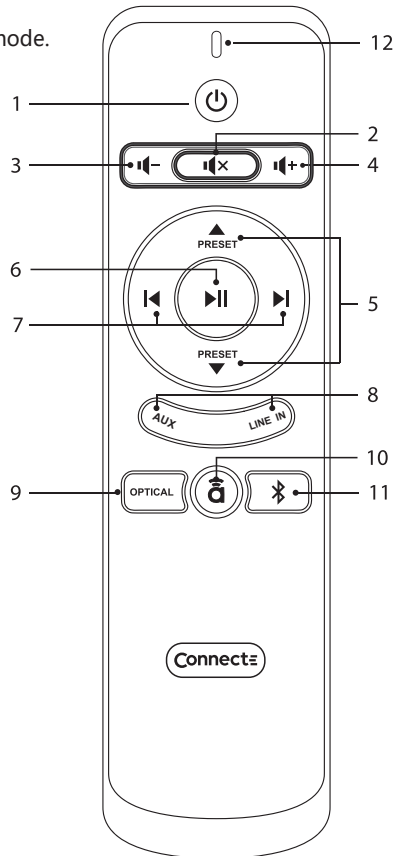

12 .LED Indicator

Preparation

Battery Replacement for the Remote Control

1. Press and slide the back cover to open the battery compartment of the remote control.



2. Insert two AAA size batteries (not included). Make sure the (+) and (-) ends of the batteries match the (+) and (-) ends indicated in the battery compartment.

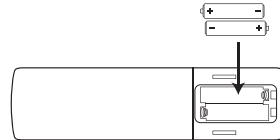

3. Close the battery compartment cover.



Handling the Battery

- Improper or incorrect use of batteries may cause corrosion or battery leakage, which could cause fire, personal injury or damage to property.
- Only use the battery type indicated in this manual.
- Do not install new batteries with used ones and do not mix different types of batteries.
- Do not dispose of used batteries as domestic waste. Dispose of them in accordance with local regulations.

Handling the Remote Control

- Do not drop the remote control.
- Do not allow anything to impact the remote control.
- Do not spill water or any liquid on the remote control.
- Do not place the remote control on a wet object.
- Do not place the remote control under direct sunlight or near sources of excessive heat.
- Remove the battery from the remote control when not in use for a long period of time, as corrosion or battery leakage may occur and result in physical injury, and / or property damage, and / or fire.
- When the battery is exhausted, the remote control will not function.

Remote Control Operation Range

The remote control is communicated to main unit via Bluetooth connection.
The maximum distance between remote control and main unit is 10 meters, omni-directionally.

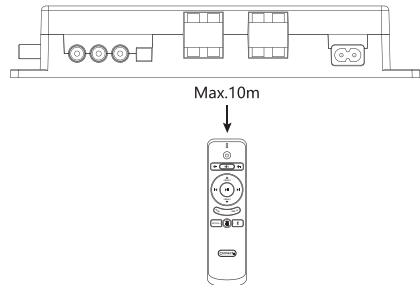

Installing the main unit

Ensure all cables to the main unit are disconnected before installing or removing the device.

Wall Mounting



- Installation must be carried out by qualified personnel only. Incorrect assembly can result in severe personal injury and property damage (if you intend to install this product yourself, you must check for installations such as electrical wiring and plumbing that may be buried inside the wall). It is the installers responsibility to verify that the wall will safely support the total load of the main unit
- Additional tools (not included) are required for the installation.
- Do not overtighten screws.
- Keep this instruction manual for future reference.
- Use an electronic stud finder to check the wall type before drilling and mounting.

Speakers System Placement

Main Unit

Main Unit carries most of the dialog as well as music and effects. It is recommended to be mounted on the wall at a conceal location. The mark is located at the bottom of the outer surface of the product.

1. Drill 4 holes (ϕ 6-8mm each according to wall type) in the wall. The distance between the holes refers to below diagram.

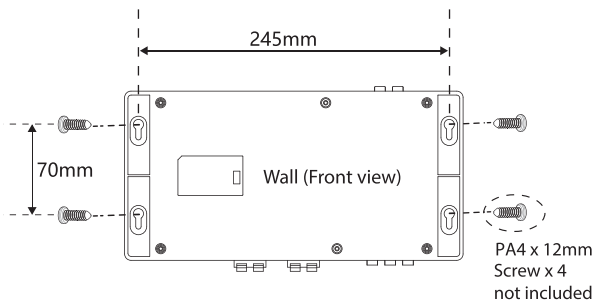

2. Firmly fix 1 dowel (not included) into each hole in the wall if necessary.

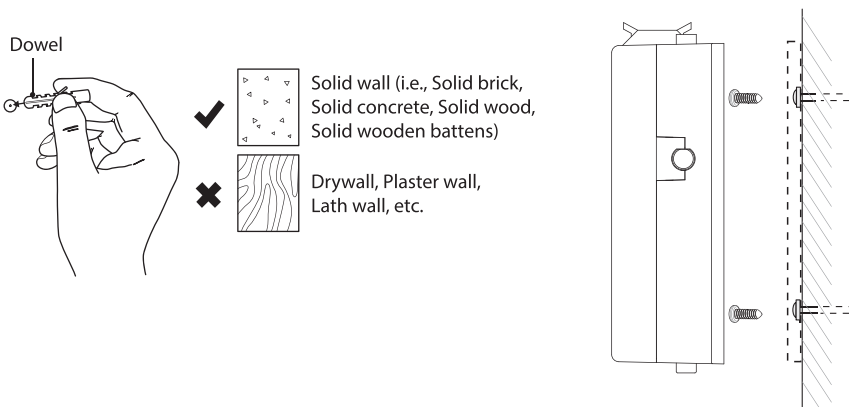

Speakers

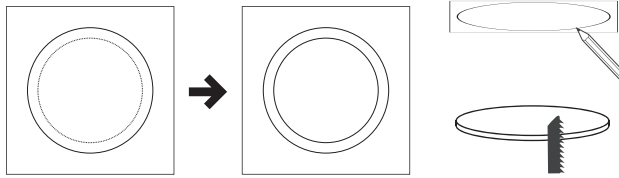

1. Press the inner circle out of the cut-out template.
2. Attach the template to the mounting surface.
3. Mark the cut-out area through the template.
4. Cut-out the hole.

Two speakers, one left channel, one right channel, are recommended mounted in ceiling. Adjust and place the speakers at proper place.
Speakers are connected to main unit with wires (included in package). Arrange wires properly to avoid any physical damages.

Drill the hole(Φ 205-230mm) in the ceiling, put the bracket inside, then tighten the screws to hold the speaker in place, finally cover the grill.

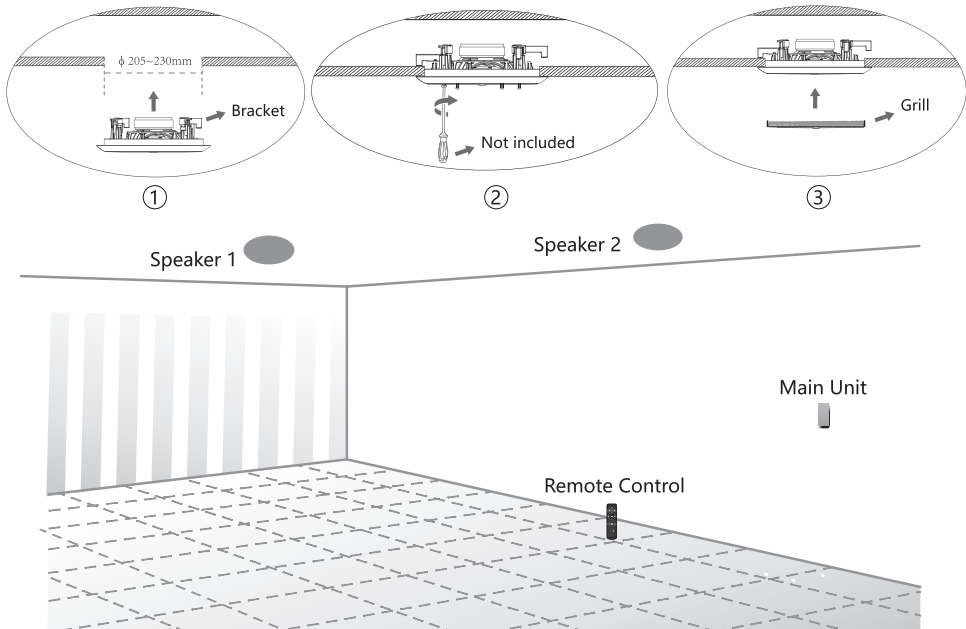

Connections

Connections for Audio Source Inputs

LINE IN connection

Use an RCA stereo audio cable to 3.5mm/RCA stereo audio cable (not included) to connect the main unit's Line-in(L/R) socket and audio output socket of other devices.

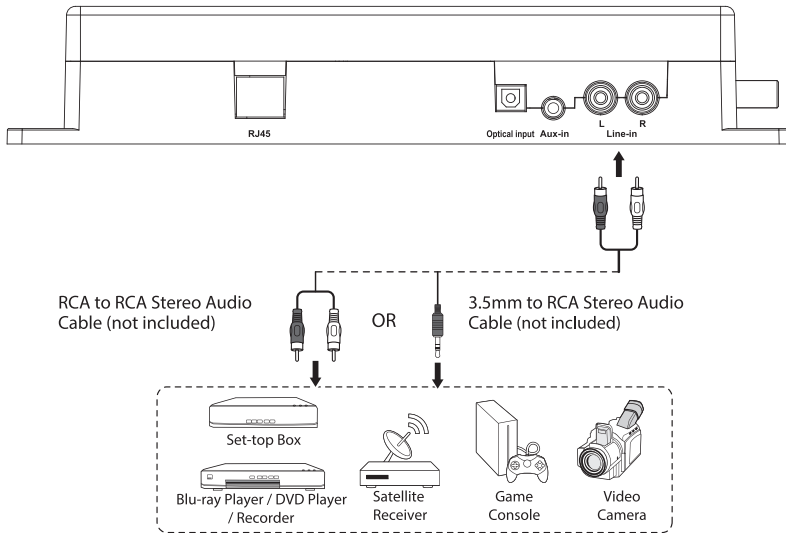

After connection, press line in icon on the Connect APP or the remote control to select line in audio to play.



Ensure to match the colours on the cable plugs to the colours on the input and output sockets.

AUX connection

Use a 3.5mm to 3.5mm/RCA stereo audio cable (not included) to connect the main unit's Aux in socket and audio output socket of other devices.

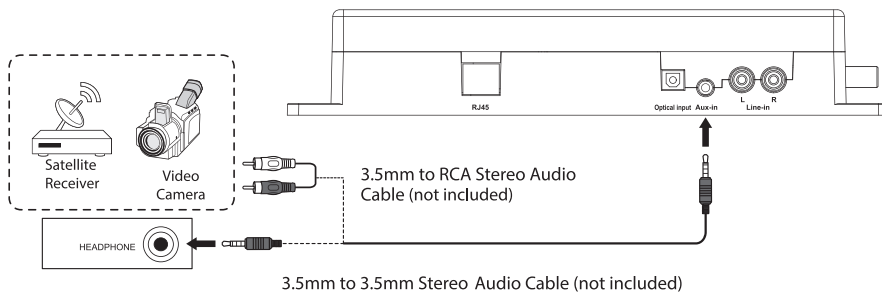

After connection, press aux icon on the Connect APP or the remote control to select AUX IN audio to play.

Optical connection

Use an optical cable (not included) to connect the main unit's optical input socket with optical output socket of other devices.

After connection, press optical icon on the Connecte APP or the remote control to select optical audio to play.

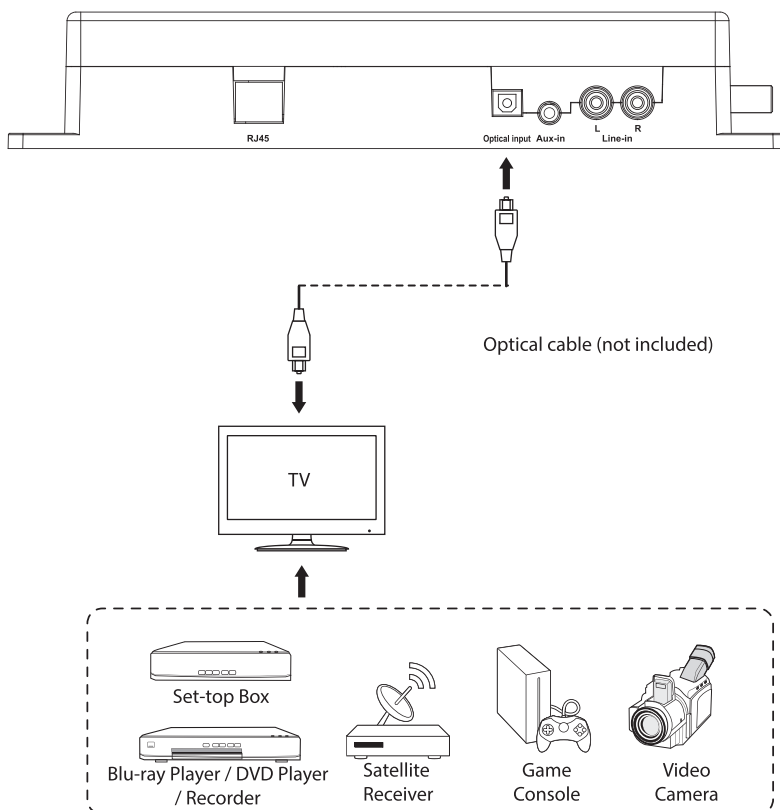

Bluetooth connection

Turn on the main unit's Bluetooth in the Connecte APP or the remote control, then turn on the Bluetooth on your device and find the main unit's Bluetooth name (Connecte Smart Sound) to establish Bluetooth connection.

Connections for audio source outputs

All external audio speakers play same audio source. The output cannot be switched unless disconnecting physical wires.

Method 1: Speakers connection

The main unit contains two sets of speaker connectors. One set includes two channels:left and right. Both two sets of speakers play same audio source.

Connect speakers to one set connector only if only two speakers are required. Wire red PIN on the main unit to red PIN on speaker and black to black. Do not disorder the wire sequence.

If you need to replace or add the speaker, please make sure that the rated power of the speaker should not be less than 10 watts.

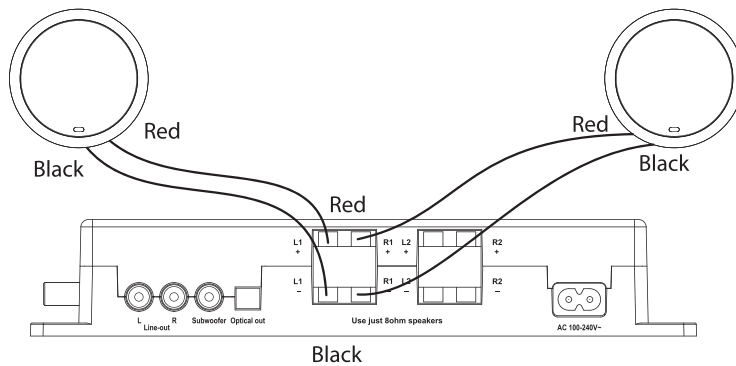

Method 2: AUX connection

The main unit can stream audio to external device through Line-out connectors.

Method 3: Optical connection

The main unit can stream audio to external device through Optical out connector.

Method 4: Subwoofer connection

The main unit can stream audio to subwoofer through subwoofer connector.

Connecting to the Mains Supply



- Connecting the unit to any other power source may damage the unit.
- Ensure all audio connections of the unit are connected before connecting to the mains power socket.
- Make sure the mains plug is firmly inserted into the mains socket.
- To switch the unit off completely, remove the mains plug from the mains socket.
- Please turn the unit off completely to save energy when not in use.
- The main cables are designed for Connecte speaker system only. DO NOT use the main cable for other purposes.

Main unit

Unwind the mains cable to its full length. Connect main cable to the AC 100V-240V socket on the main unit, and a mains socket at the other end directly.

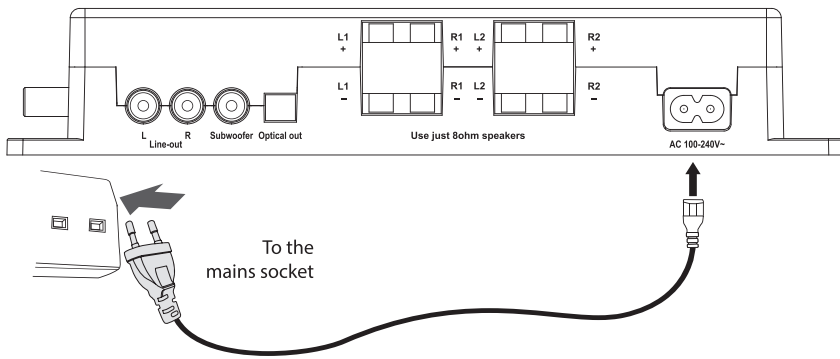

Full units Setup

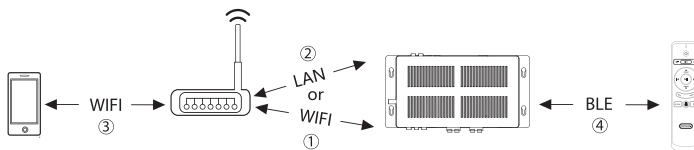

Step 1 Connecting main unit to wireless router

Google cast is available on unit if the router is connected to the internet.

There are two ways to connect the main unit to wireless router: Connect the main unit's RJ45 socket and the wireless router directly with a network cable or via wifi, then Setting via Google Home. We recommend using a cable.

The way to setup via Google Home: please visit Apple "App Store" or Google "Play Store" to download Google home App.

1. Install and launch Google Home App.
2. Start Google Home app and follow the steps.
 - I Click the "+" icon
 - II Click "Set up device"
 - III Click "Set up new devices in your home"
 - IV Choose existing home or add another home.
 - V If your location services are turned off in your device's setting, enable your location services.
 - VI Turn on bluetooth to improve connection to your device.
 - VII Choose the device "Connecte Smart Sound"
 - VIII Waiting for connecting to "Connecte Smart Sound"
 - IX If you hear a sound, you're connected to "Connecte Smart Sound"
 - X Choose a location for your "Connecte Smart Sound" and click "NEXT"
 - XI Choose a WiFi network and click "NEXT"
 - XII Waiting for connecting to WiFi.

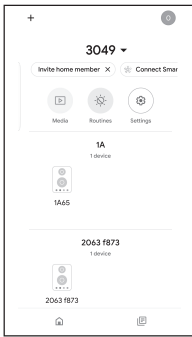

I

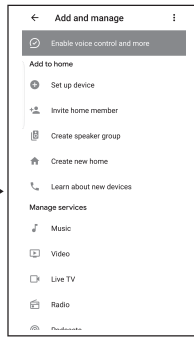

II

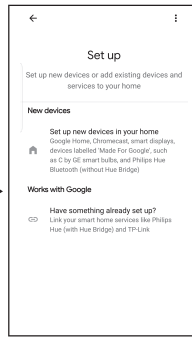

III

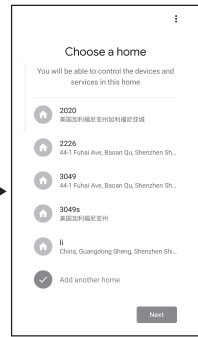

IV

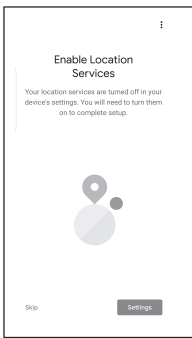

V

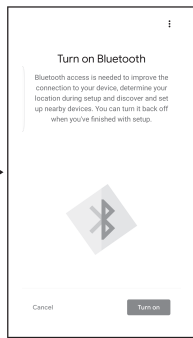

VI

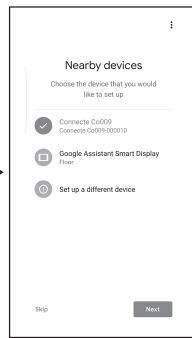

VII

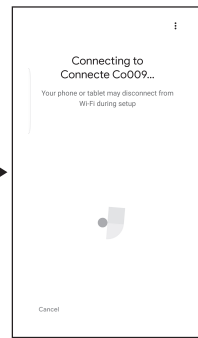

VIII

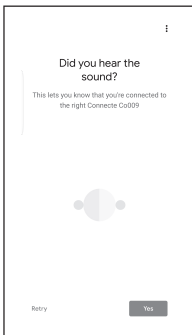

IX

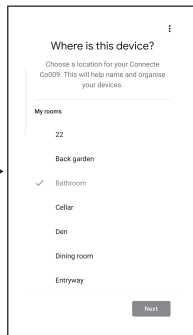

X

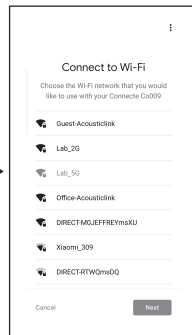

XI

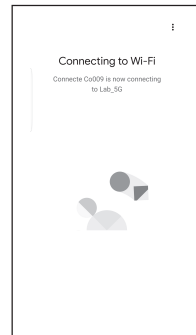

XII

3. After successful network setup, you can stream music from online music app, such as Spotify, TuneIn, Library SoundCloud and so on.

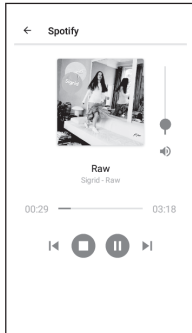

Step 2 Pairing the remote control with main unit

After remote control is powered with two AAA batteries and the main unit powered on, long press "⏻" together with "▶||", led indicator will flashing, then entering to pairing mode, led indicator goes off when paired successfully.

Step 3 Connecting smart phone to the same with router

After setting the main unit, please connect the smart phone to the same router, so that the smart phone can cast the audio to the main unit.

General operations

Standby/ON for main unit

When you first connect the unit to the main socket, the unit shall be in ON mode. After the unit is idle for 10 mins, the device shall enter Standby mode. To manually enter Standby mode, press "⏻" on the remote control, press again to switch the unit back to ON mode. The default standby timeout is 10 mins.

You can press the "⏻" on the remote control to standby as well as wake up the main unit.

Selecting Audio source

The device has radio, Aux in, Line in(RCA), Bluetooth, OPTICAL, and Google cast audio sources input, each source except Google Cast can be selected by remote control and Connecte APP; Google cast is controlled by Google home APP, also it's the priority source input.

Connecte APP

Downloading the Connecte APP

For access to extended functionality, including Product Firmware Updates, Source Selection Volume +/-, download the free Connecte APP, available from the App Store or Google Play Store.

Set up your device in the Connecte APP located on your phone or pad.

1. Connect your smart device to the same network as system.
2. Follow the Connecte APP configure process.

I Open the Connecte APP.

II Click the "Add Device"icon.

III Click the"Auto Scan"icon, selected "Start scanning".

IV Search the device and when you find the the device "Connecte Smart Sound", click"Next"icon.

V Setting up successfully, click "Done"icon.

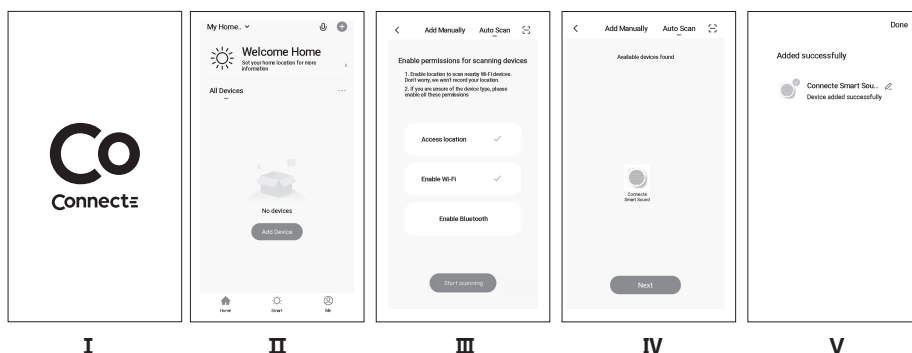

From the menu, you can choose the source input from OPTICAL, AUX, LINE IN, RADIO, BLUETOOTH and make some settings.

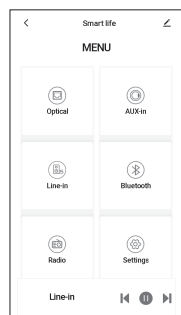

Choosing RADIO source, as shown below.

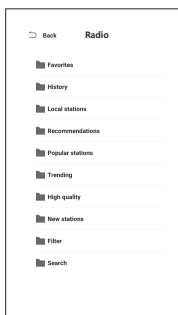

Choosing BLUETOOTH source, as shown below.

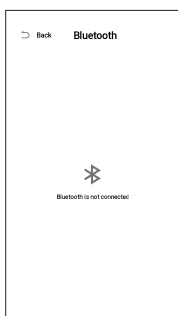

- Turn on the Bluetooth on your device and find the main unit's Bluetooth name(Connecte Smart Sound) to establish connection, play music on your device.
- Back to app's interface,select current connected bluetooth device.
- Click"Play"to enter playing interface.
 - A. Click"Play"to enter playing interface.
 - B. If you want to connect to another device,click "Disconnect" to disconnect the current connected bluetooth device and enter pairing mode.
 - C. If you want to unpaired current device,click"Unpair" to unpair current connected bluetooth device and enter pairing mode , current device will be cleared from paired list.
 - D. If you want to reconnected your bluetooth device,make sure your bluetooth device's bluetooth function is turned on,click "Connect" to reconnect current device.

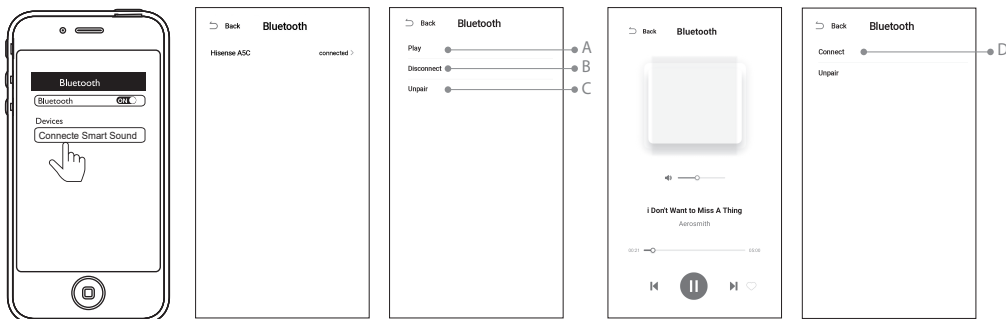

Choosing OPTICAL/AUX/LINE IN source,as shown below:



Factory default settings

When the unit is powered on, press the "PRESET / " , "▲" , "▶" , "▶" , "▶" buttons of the remote control in order, reset the unit to factory default settings.

Maintenance





Ensure the unit is fully unplugged from the mains socket before cleaning.

- To clean the units, wipe the case with a slightly moist, lint-free cloth.
- Do not use any cleaning fluids containing alcohol, ammonia or abrasives.
- Do not spray aerosol at or near the unit.

Hints and Tips

If a problem does occur, it may often be due to something very minor. The following table contains various tips. If you require additional assistance please click on the link for Support Centre:

www.connecte.no

Problem	Solution
No power.	<ul style="list-style-type: none"> • Ensure the mains plug is connected. • Make sure that you select the On mode.
The remote control does not function.	<ul style="list-style-type: none"> • Use the remote control near the unit. • Point the remote control at the remote sensor on the unit. • Replace the battery in the remote control with a new one. • Remove any obstacles between the remote control and the unit.
Loud hum or noise is heard.	<ul style="list-style-type: none"> • The plugs and sockets are dirty. Wipe them with a cloth slightly moistened with alcohol.
No sound from Speaker	<p>Please try either one of the solutions below:</p> <ul style="list-style-type: none"> • Make sure that the unit is not muted. Press  or VOL +/- button to resume normal listening. • Press  on the remote control to switch the main to standby mode. Then press the button again to switch the unit on. • The unit may not be able to decode all digital audio formats from the input source. In this case, the unit will mute. This is NOT a defect.

Product Specification

Main Unit	
Power Supply	AC 100-240V~ 50Hz
Dimension	L266*W145*H46.5mm
Net Weight	611g
Power Consumption	50W
WiFi	802.11 A/B/G/N/AC
Bluetooth	4.2
Speaker	
Driver	8Ω 10W
Dimension	φ 233.5*H71.5mm
Net Weight	1230g

Connecte AS

Tel: +47 916 44 464

E-mail: info@connecte.no

www.connecte.no